

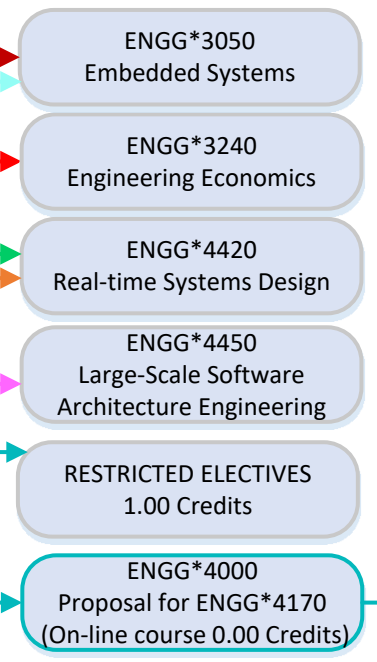

FALL

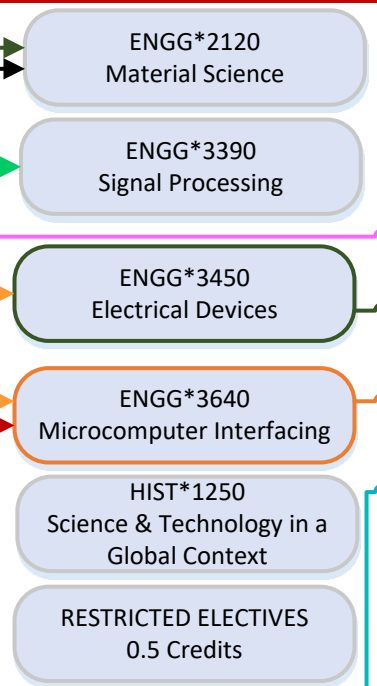

WINTER

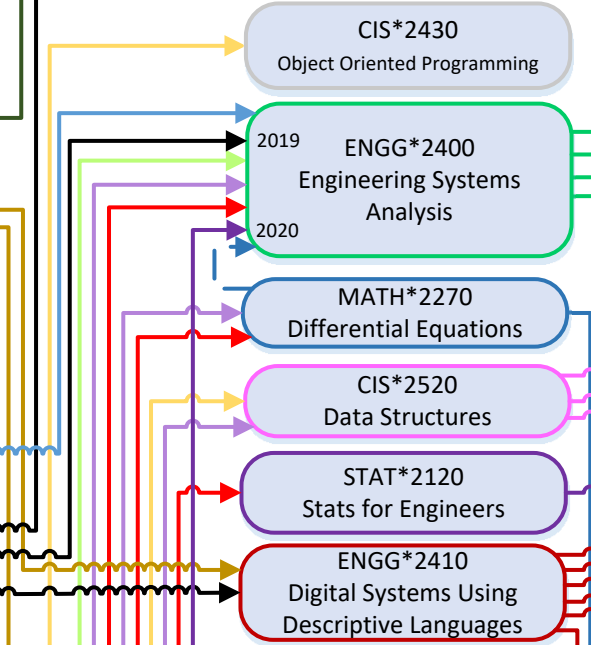
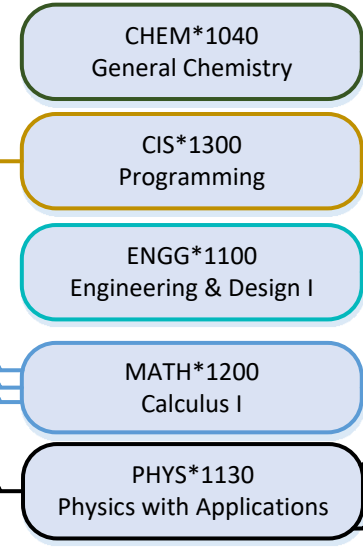
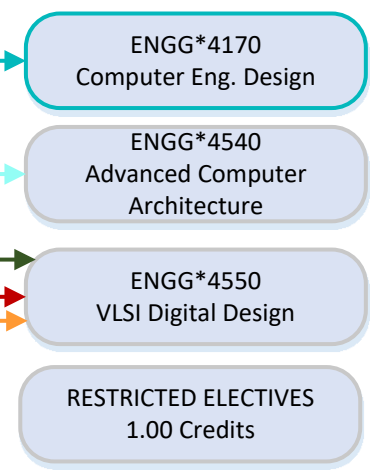
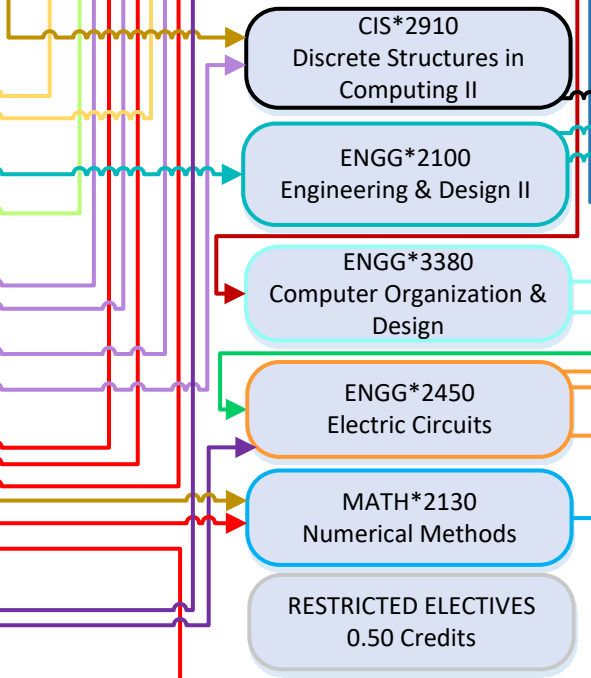
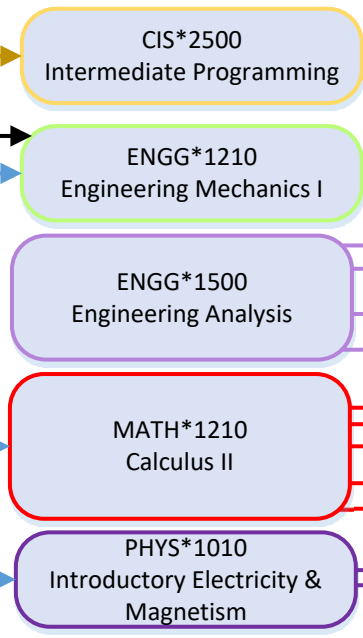

TITLE 2019/2020 COMPUTER ENGINEERING PROGRAM MAP	
LEGEND PREREQUISITE → COREQUISITE ⇌	REVISED 06-09-2020
NOTES 1. NOT THE OFFICIAL SCHEDULE OF STUDIES; FOR GUIDANCE PURPOSES ONLY	